

**STAINLESS STEEL FITTINGS PN20**



Lloyd's  
Register

ISO 9001 : 2008



**Size :** DN 1/8" to DN 4"  
**Ends :** Male, female or welding  
**Min Temperature :** - 25°C  
**Max Temperature :** + 180°C  
**Max Pressure :** 20 Bars  
**Specifications :** "Lost wax" moulding  
Threaded BSP

**Materials :** Stainless steel

## STAINLESS STEEL FITTINGS PN20

### SPECIFICATIONS :

- " Lost wax " moulding
- Male conic threaded BSP
- Female cylindric threaded BSP

### USE :

- For all common fluids
- Min Temperature Ts : - 25°C
- Max Temperature Ts :+ 180°C
- Max Pressure Ps : 20 bars

### RANGE :

- From DN 1/8" to DN 4"
- ASTM A351 CF8M fittings excepted for Ref.2034, 2038, 2039, 2040, 2041 and 2042 in SS ASTM A182 F316

### SIZE ( in mm ) :

- **Elbow 90° F. F. ( DN 1/8"– 4" ) Ref. 2001**

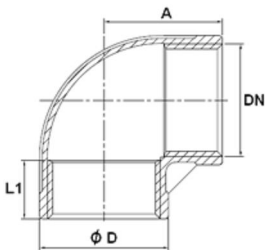

DN	1/8"	1/4"	3/8"	1/2"	3/4"	1"	1"1/4	1"1/2	2"	2"1/2	3"	4"
A	17	19	21.5	27	30	35	43	45	54	69	77	92.5
Ø D	13.9	17.4	20.9	24.9	31.2	38.1	47.4	54.1	66.6	82.4	95.9	121.8
L1	6.5	9.7	10.1	11	11.4	13.8	14.5	14.9	15.7	25.4	27	29.5
Weig. (Kg)	0.018	0.029	0.043	0.053	0.079	0.131	0.204	0.263	0.433	0.757	1.083	1.724

- **Elbow 90° M. F. ( DN 1/8"– 3" ) Ref. 2010**

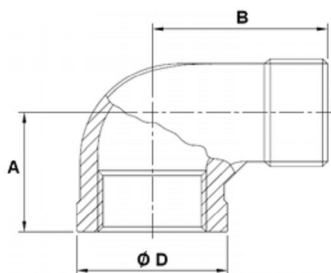

DN	1/8"	1/4"	3/8"	1/2"	3/4"	1"	1"1/4	1"1/2	2"	2"1/2	3"
A	19	21.5	24.5	29	33.5	37	43	47	57.5	66	74
B	26.5	30.8	36.5	41	48	55	62	67	77.5	93	107
Ø D	13.9	17.2	20.9	24.9	31.2	38.1	47.4	54.1	66.6	87.4	101.8
Weig. (Kg)	0.015	0.028	0.043	0.054	0.084	0.139	0.189	0.277	0.412	0.913	1.65

**STAINLESS STEEL FITTINGS PN20**
**SIZE ( in mm ) :**

- Tee F. F. F. ( DN 1/8"– 4" ) Ref. 2003

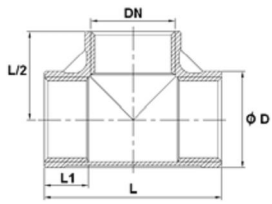

DN	1/8"	1/4"	3/8"	1/2"	3/4"	1"	1"1/4	1"1/2	2"	2"1/2	3"	4"
Ø D	13.9	17.4	20.9	24.9	31.2	38.1	47.4	54.1	66.6	82.4	95.9	121.8
L	34	39	44	55	60	70	85	89	107	136	154	185
L1	6.5	9.7	10.1	11	11.4	13.8	14.5	14.9	15.7	25.4	27	29.5
Weig. (Kg)	0.026	0.041	0.059	0.073	0.108	0.168	0.260	0.34	0.53	0.878	1.198	2.056

- Cross F. F. F.F. ( DN 1/8"– 4" ) Ref. 2002

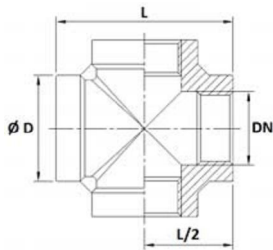

DN	1/8"	1/4"	3/8"	1/2"	3/4"	1"	1"1/4	1"1/2	2"	2"1/2	3"	4"
Ø D	14.8	18.5	22.1	28.8	33.7	42	50.4	57.1	69.2	89.2	99.5	126
L	34.1	38	44	55	63.4	73.2	85.6	89.8	108	137.2	143	180
L/2	17.05	19	22	27.5	31.7	36.6	42.8	44.9	54	86.6	71.5	90
Weig. (Kg)	0.037	0.056	0.08	0.16	0.22	0.365	0.48	0.57	0.9	1.606	2	3.3

- Reduced nipple F. F. ( DN 1/8"– 2" ) Ref. 2013

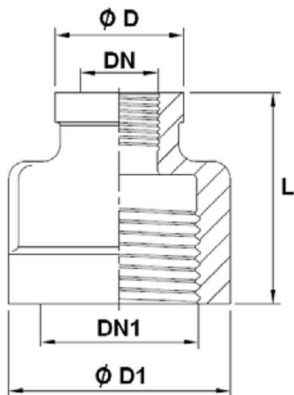

DN	1/8"	1/4"	3/8"	1/2"	3/4"	1"	1"1/4	1"1/2
DN1	1/4"	3/8"	1/2"	3/4"	1"	1"1/4	1"1/2	2"
Ø D	15.5	18.2	23	28	34	41.6	50	57
Ø D1	18	22	28.5	34	41.5	50	57	70
L	24	29	34.5	36.5	41.5	47	51.5	59
Weight (Kg)	0.020	0.030	0.066	0.082	0.115	0.186	0.24	0.387

**STAINLESS STEEL FITTINGS PN20**
**SIZE ( in mm ) :**

- Double reduced nipple F. F. ( DN 1/8"– 2" ) Ref. 2014

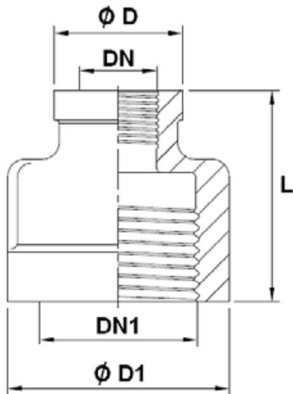

DN	1/8"	1/4"	3/8"	1/2"	3/4"	1"	1"1/4
DN1	3/8"	1/2"	3/4"	1"	1"1/4	1"1/2	2"
Ø D	18.1	19.5	28.2	29	34	41.5	56.5
Ø D1	22	28.5	34	41.5	50	57	70
L	29	34	36.5	42	46	50	59
Weight (Kg)	0.035	0.06	0.092	0.121	0.175	0.235	0.447

- Socket bright F. F. ( DN 1/8"– 4" ) Ref. 2015

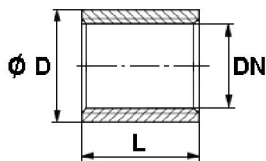

DN	1/8"	1/4"	3/8"	1/2"	3/4"	1"	1"1/4	1"1/2	2"	2"1/2	3"	4"
Ø D	14	18.5	21.5	26.5	32	40	48	55	66	82	95	122
L	17	25	26.5	34	36	43	48	48	56	65	71	83
Weig. (Kg)	0.013	0.031	0.034	0.068	0.084	0.141	0.195	0.235	0.302	0.510	0.670	1.200

- Half socket F. F. ( DN 1/8"– 2" ) Ref. 2017

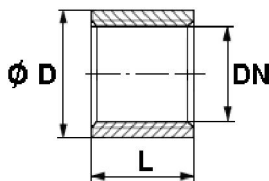

DN	1/8"	1/4"	3/8"	1/2"	3/4"	1"	1"1/4	1"1/2	2"
Ø D	14	19	22	26	32	40	48	55	66
L	10	11	13	16	18	20	22	23	27
Weig. (Kg)	0.008	0.014	0.018	0.029	0.038	0.052	0.086	0.095	0.161

- Reduced nipple M. F. ( DN 1/8"– 2" ) Ref. 2021

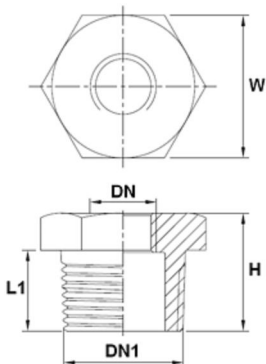

DN	1/8"	1/4"	3/8"	1/2"	3/4"	1"	1"1/4	1"1/2
DN1	1/4"	3/8"	1/2"	3/4"	1"	1"1/4	1"1/2	2"
H	15	16.5	20	21.5	24.5	27.5	28	31
L1	12.5	13	16	17	20	22	22	23.5
W	15	18	23	29	35	45	50	62
Weig. (Kg)	0.012	0.015	0.028	0.038	0.069	0.107	0.132	0.23

**STAINLESS STEEL FITTINGS PN20**
**SIZE ( in mm ) :**

- Double reduced nipple M. F. ( DN 1/8"– 2" ) Ref. 2024

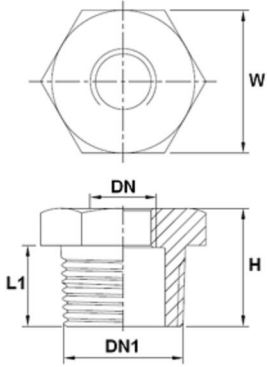

DN	1/8"	1/4"	3/8"	1/2"	3/4"	1"	1"1/4"
DN1	3/8"	1/2"	3/4"	1"	1"1/4"	1"1/2"	2"
H	16.5	20	21.5	24.5	27.5	28	31
L1	13	16	17	20	22	22	23.5
W	18	23	29	35	45	50	62
Weig. (Kg)	0.022	0.029	0.052	0.08	0.134	0.157	0.278

- Hexagon hollow plug ( DN 1/2"– 2" ) Ref. 2022

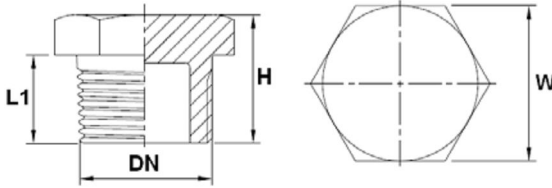

DN	1/2"	3/4"	1"	1"1/4"	1"1/2"	2"
H	22.6	23.3	26.8	30.5	30.8	34
L1	16	16.5	19	21	21	22.8
W	25.2	29.7	36.5	45.3	51.4	62.5
Weight (Kg)	0.040	0.056	0.087	0.141	0.190	0.280

- Hexagon plain plug ( DN 1/8"– 2" ) Ref. 2023

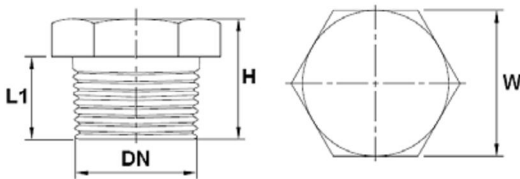

DN	1/8"	1/4"	3/8"	1/2"	3/4"	1"	1"1/4"	1"1/2"	2"
H	19	19	19	22	26	28	33	35	39
L1	11	12	13	16	17	19	21	23	27
W	12	16	19	23	28	36	46	50	65
Weig. (Kg)	0.013	0.024	0.036	0.061	0.115	0.198	0.384	0.509	0.913

- Square plug ( DN 1/8"– 2" ) Ref. 2020

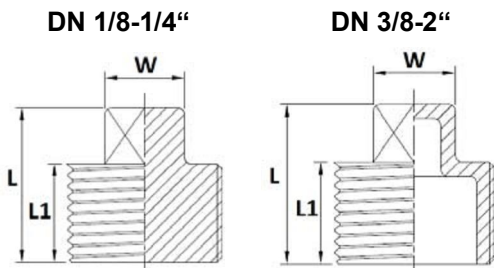

DN	1/8"	1/4"	3/8"	1/2"	3/4"	1"	1"1/4"	1"1/2"	2"
L	18	20	20	25	26.5	33	35	35	40
L1	11	12	12	15	15.5	20	20	20	23
W	7.2	8	10	13	16	19	22	25	29
Weig. (Kg)	0.009	0.015	0.017	0.03	0.044	0.075	0.115	0.14	0.215

**STAINLESS STEEL FITTINGS PN20**
**SIZE ( in mm ) :**

- Female hexagon cap ( DN 1/4"– 2" ) Ref. 2037

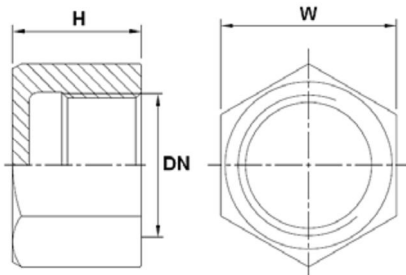

DN	1/4"	3/8"	1/2"	3/4"	1"	1"1/4	1"1/2	2"
H	17	17.5	20	20.4	27.1	30	30.3	32.3
W	17.5	21.2	25.5	30.1	37.4	47	53.2	66
Weight (Kg)	0.022	0.031	0.042	0.051	0.095	0.153	0.188	0.304

- Union F.F. ( DN 1/4"– 2" ) Ref. 2025 - Conical seat

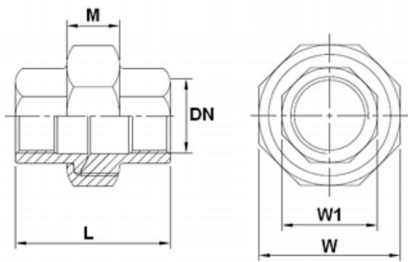

DN	1/4"	3/8"	1/2"	3/4"	1"	1"1/4	1"1/2	2"
L	34.5	37.6	38.6	44	51	58	59	61.5
M	12.2	15	15	15	17	20	20	20.8
W	28	34	39.2	46	55	63.5	71	85
W1	17.5	20.5	26.5	31.2	38	47.5	54	67
Weight (Kg)	0.069	0.098	0.149	0.191	0.299	0.386	0.482	0.716

DN 1/4" :



DN 3/8" - 1" :

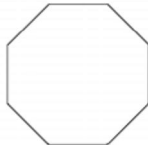

DN 1"1/4 - 2" :

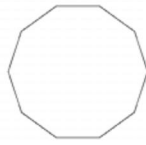

- Union M.F. ( DN 1/4"– 2" ) Ref. 2026 - Conical seat

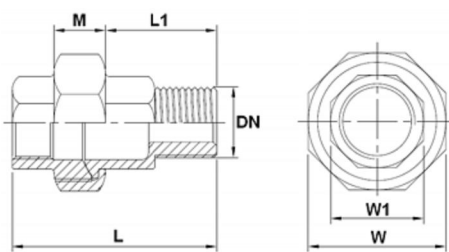

DN	1/4"	3/8"	1/2"	3/4"	1"	1"1/4	1"1/2	2"
L	46	48	52.8	58.6	66.5	73.5	74.5	80.5
L1	22.7	21.5	26	28.6	32.2	35	35	39
M	12.2	15	15	15	17	20	20	20.8
W	28	34	39.2	46	55	63.5	71	85
W1	17.2	20.3	26	30.6	38	47.3	53	66
Weight (Kg)	0.074	0.107	0.164	0.224	0.336	0.443	0.538	0.839

DN 1/4" :



DN 3/8" - 1" :

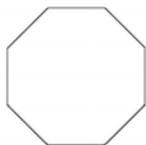

DN 1"1/4 - 2" :

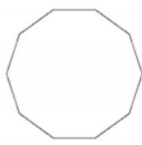

STAINLESS STEEL FITTINGS PN20

**SIZE ( in mm ) :**

- Union Male - Male ( DN 1/4"– 2" ) Ref. 2062 - Conical seat

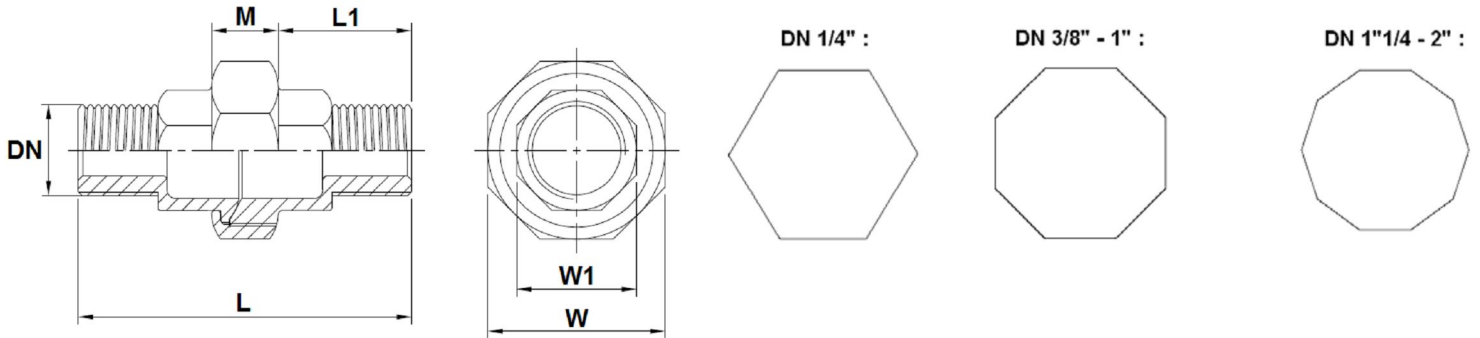

DN	1/4"	3/8"	1/2"	3/4"	1"	1 1/4"	1 1/2"	2"
L	56	57.5	66.5	73.4	81	89.5	89.3	99
L1	21	21	26.1	29.6	32	34.5	34	39
M	12.2	15	15	15	17	20	20	20.8
W	28	34	39.2	46	55	63.5	71	85
W1	17	20	26.5	31	38.4	47.3	53	66
Weig. (Kg)	0.085	0.112	0.175	0.246	0.358	0.502	0.614	0.946

- Union Male – But Welding ( DN 1/4"– 2" ) Ref. 2027 - Conical seat

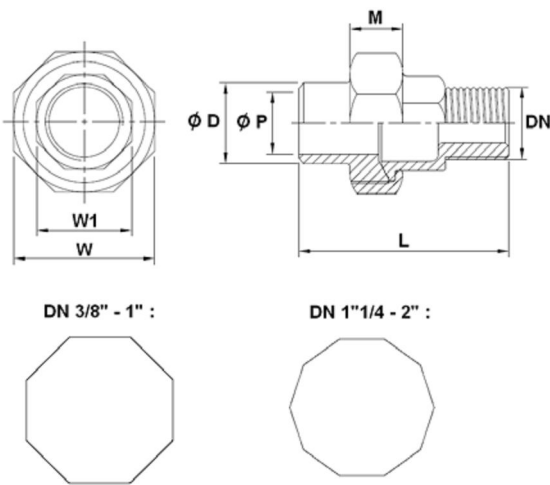

DN	1/4"	3/8"	1/2"	3/4"	1"	1 1/4"	1 1/2"	2"
Ø D	13.5	17.2	21.5	27	33.7	42.7	48.5	60.5
Ø P	9.4	12.6	16	21.5	27	35.6	41.5	52.7
L	46.4	47.7	53	60	66	72	73	77.6
M	12.2	15	15	15	17	20	20	20.8
W	28	34	39.2	46	55	63.5	71	85
W1	17.2	20.3	26	30.6	38	47.3	53	66
Weight (Kg)	0.069	0.104	0.153	0.225	0.328	0.432	0.535	0.765

**STAINLESS STEEL FITTINGS PN20**
**SIZE ( in mm ) :**

- Union Female – But Welding ( DN 1/4"– 2" ) Ref. 2028 - Conical seat

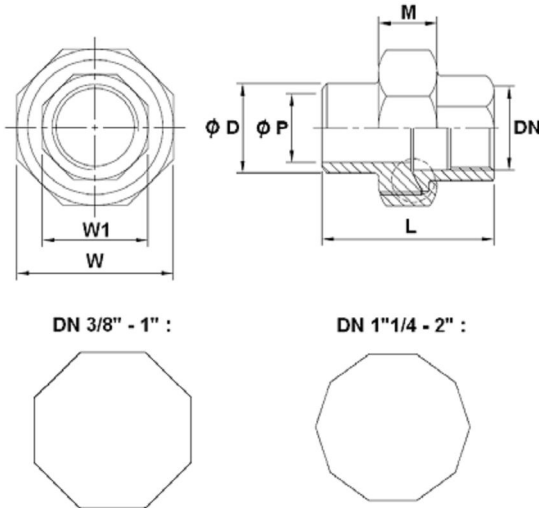

DN	1/4"	3/8"	1/2"	3/4"	1"	1"1/4	1"1/2	2"
Ø D	13.5	17.2	21.5	27	33.7	42.7	48.5	60.5
Ø P	9.4	12.6	16	21.5	27	35.6	41.5	52.7
L	35	38	40	45.7	50	56	57	58.6
M	12.2	15	15	15	17	20	20	20.8
W	28	34	39.2	46	55	63.5	71	85
W1	17.4	20.3	26.5	31	38	47.3	53.3	66.5
Weight (Kg)	0.065	0.113	0.145	0.185	0.290	0.395	0.465	0.675

- Union B.W. – B.W. ( DN 8– DN 50 ) Ref. 2029 - Conical seat

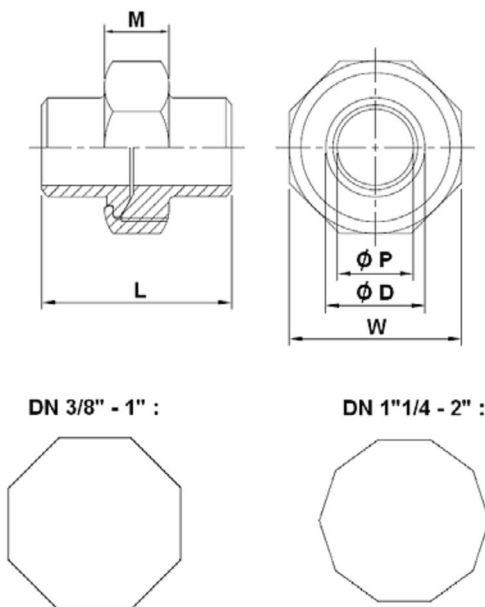

DN	8	10	15	20	25	32	40	50
Ø D	13.5	17.2	21.5	27	33.7	42.7	48.5	60.5
Ø P	9.4	12.6	16	21.5	27	35.6	41.5	52.7
L	34.5	38.5	40	47.5	49.6	54.8	55	57.4
M	12.2	15	15	15	17	20	20	20.8
W	28	34	39.2	46	55	63.5	71	85
Weight (Kg)	0.06	0.107	0.144	0.203	0.310	0.42	0.510	0.765



**STAINLESS STEEL FITTINGS PN20**
**SIZE ( in mm ) :**

- Hexagon nipple ( DN 1/8"– 2" ) Ref. 2030

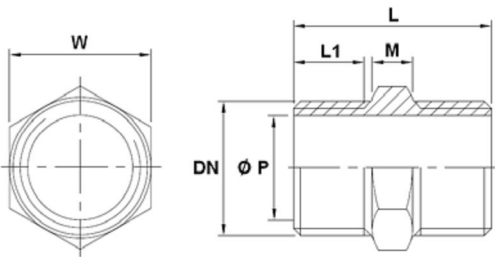

DN	1/8"	1/4"	3/8"	1/2"	3/4"	1"	1"1/4	1"1/2	2"
L	26	30	30	40	40.5	48	49.5	49.5	52.5
L1	9	11	11	14	14	17.5	18	18.5	20
M	5.6	6	6	7.6	8.5	8	9.5	9.5	10.5
Ø P	5.5	8.2	11.8	15.2	21	26.5	35	41	53
W	13	15	18	23	29	35	45	50	62
Weig. (Kg)	0.012	0.019	0.023	0.046	0.062	0.104	0.152	0.169	0.231

- Reduced nipple male - male ( DN 1/8"– 2" ) Ref. 2031

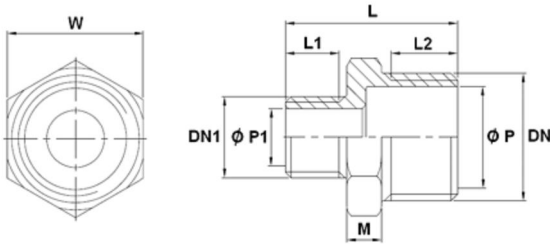

DN	1/4"	3/8"	1/2"	3/4"	1"	1"1/4	1"1/2	2"
DN1	1/8"	1/4"	3/8"	1/2"	3/4"	1"	1"1/4	1"1/2
L	29	32	36	39	45	50	50.5	52
L1	10	11	12	14	14	17.5	18	18.5
L2	11	12	14	14	17.5	18	18.5	20
M	6	7	7	7	9	10	10.5	11
Ø P	8.2	11.8	15.2	21	27	35	41	51.8
Ø P1	5.5	8.2	11.8	15.2	21	27	35	41
W	15	18	23	29	35	45	50	62
Weight (Kg)	0.016	0.025	0.041	0.057	0.088	0.151	0.184	0.267

- Double reduced nipple male - male ( DN 1/8"– 2" ) Ref. 2032

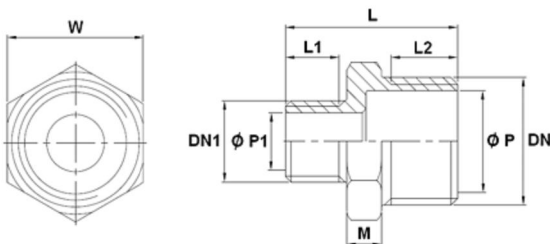

DN	3/8"	1/2"	3/4"	1"	1"1/4	1"1/2	2"
DN1	1/8"	1/4"	3/8"	1/2"	3/4"	1"	1"1/4
L	31	35	36	45	46	50.5	52
L1	10	11	12	14	14	17.5	18
L2	12	14	14	17.5	18	18.5	20
M	7	7	7	9	10	10.5	11
Ø P	11.8	15.2	21	27	35	41	51.8
Ø P1	5.5	8.2	11.8	15.2	21	27	35
W	18	23	29	35	45	50	62
Weight (Kg)	0.022	0.039	0.051	0.093	0.143	0.187	0.281

**STAINLESS STEEL FITTINGS PN20**
**SIZE ( in mm ) :**

- Reduced nipple female - male ( DN 1/8"– 2" ) Ref. 2033

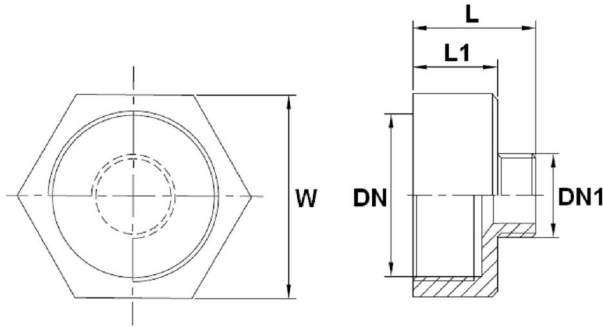

DN	1/4"	3/8"	1/2"	3/4"	1"	1"1/4	1"1/2	2"
DN1	1/8"	1/4"	3/8"	1/2"	3/4"	1"	1"1/4	1"1/2
L	27	31	35	38.5	44	47	50	53
L1	16.5	18.5	22	23	26	27	28	30
W	17	21	26	32	38	46	54	63
Weig. (Kg)	0.024	0.039	0.068	0.104	0.127	0.170	0.265	0.290

- Hose nozzle ( DN 1/4"– 2" ) Ref. 2035

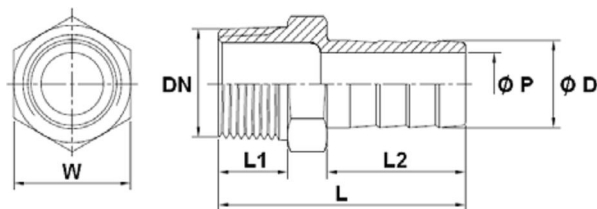

DN	1/4"	3/8"	1/2"	3/4"	1"	1"1/4	1"1/2	2"
L	43	49	56.5	60	69	70	80	88
L1	11.5	13	15	15.5	19	22	22	22.5
L2	25	29.5	33	34	39	37	47.5	53.5
Ø D	8	10	13	20	25	32	40	51.5
Ø P	4	5	7	15	19.5	26.5	33.5	44
W	15	19	23	28	37	45	50	62
Weig. (Kg)	0.020	0.034	0.055	0.084	0.133	0.196	0.286	0.44

- Hexagon nut ( DN 1/8"– 2" ) Ref. 2036

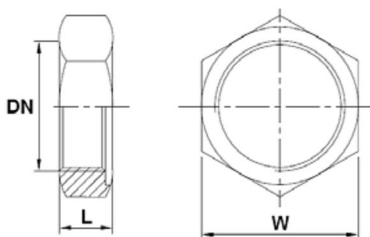

DN	1/8"	1/4"	3/8"	1/2"	3/4"	1"	1"1/4	1"1/2	2"
L	6.3	7	7.5	7.7	9.2	9	11.7	11.8	13.1
W	17.3	19.1	25.3	30.1	34.4	43.2	52	58.1	71.9
Weig. (Kg)	0.008	0.009	0.018	0.024	0.032	0.048	0.086	0.097	0.155

**STAINLESS STEEL FITTINGS PN20**
**SIZE ( in mm ) :**

- Welding nipple L=50 mm ( DN 1/4"– 2" ) Ref. 2034

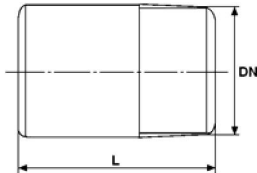

DN	1/4"	3/8"	1/2"	3/4"	1"	1"1/4	1"1/2	2"
L	50	50	50	50	50	50	50	50
Weig. (Kg)	0.025	0.039	0.05	0.06	0.093	0.135	0.126	0.215

- Standard welding nipple ( DN 1/4"– 4" ) Ref. 2039

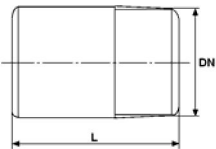

DN	1/4"	3/8"	1/2"	3/4"	1"	1"1/4	1"1/2	2"	2"1/2	3"	4"
L	22	23	27	33	35	36	41	46	55	70	80
Weig. (Kg)	0.010	0.013	0.025	0.037	0.061	0.074	0.106	0.176	0.295	0.461	0.66

- Welding nipple L=100 mm ( DN 1/4"– 2" ) Ref. 2042

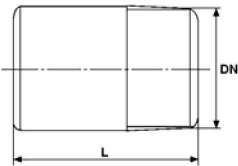

DN	1/4"	3/8"	1/2"	3/4"	1"	1"1/4	1"1/2	2"
L	100	100	100	100	100	100	100	100
Weight (Kg)	0.050	0.078	0.116	0.139	0.186	0.270	0.32	0.430

- Barrel nipple L=100 mm ( DN 1/4"– 2" ) Ref. 2038

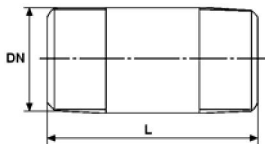

DN	1/4"	3/8"	1/2"	3/4"	1"	1"1/4	1"1/2	2"
L	100	100	100	100	100	100	100	100
Weight (Kg)	0.051	0.063	0.105	0.127	0.185	0.229	0.262	0.39

- Standard barrel nipple ( DN 1/4"– 4" ) Ref. 2040

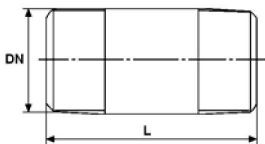

DN	1/4"	3/8"	1/2"	3/4"	1"	1"1/4	1"1/2	2"	2"1/2	3"	4"
L	40	40	60	60	60	80	80	100	100	120	120
Weig. (Kg)	0.019	0.022	0.058	0.066	0.1	0.169	0.193	0.390	0.438	0.743	0.95

- Barrel nipple L=200 mm ( DN 1/4"– 2" ) Ref. 2041

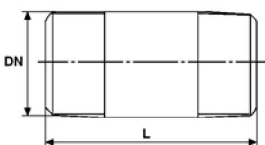

DN	1/4"	3/8"	1/2"	3/4"	1"	1"1/4	1"1/2	2"
L	200	200	200	200	200	200	200	200
Weight (Kg)	0.102	0.126	0.210	0.254	0.370	0.52	0.59	0.780

## STAINLESS STEEL FITTINGS PN20

### STANDARDS :

- Fabrication according to ISO 9001 : 2008
- DIRECTIVE 97/23/CE : Products excluded from directive ( Article 1,§3.2 )
- Male conical BSP threaded according to ISO 7/1 R for Ref. 2010, 2020, 2021, 2022, 2023, 2024, 2026, 2027, 2030, 2031, 2032, 2033, 2034, 2035, 2038, 2039, 2040, 2041, 2042 and 2062
- Female cylindrical BSP threaded according to ISO 228-1 for Ref. 2015 and 2017
- Female cylindrical BSP threaded according to ISO 7/1 Rp for Ref. 2001, 2002, 2003, 2010, 2013, 2014, 2021, 2024, 2025, 2026, 2028, 2033, 2036 and 2037

**ADVICE :** Our opinion and our advice are not guaranteed and SFERACO shall not be liable for the consequences of damages.  
The customer must check the right choice of the products with the real service conditions.